



# Thule Rapid System Kit 4091 Thule Podium Kit 4091

# > Instructions

**OPEL Crossland X**, 5-dr SUV, 17-  
**VAUXHALL Crossland X**, 5-dr SUV, 17-  
**OPEL Grandland X**, 5-dr SUV, 18-  
**VAUXHALL Grandland X**, 5-dr SUV, 18-

**This kit is only for vehicles with flush side railing.**

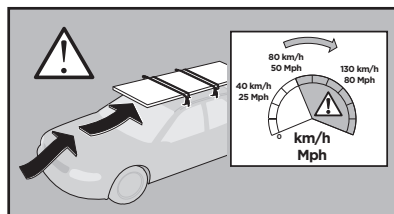
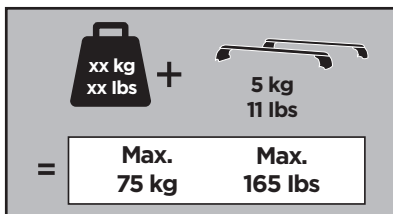
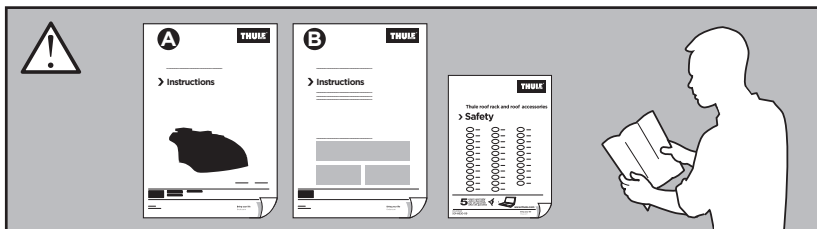

ISO 11154-E

184091

C.20171026  
509-4091-02

Herbály Autó [www.herbalyauto.hu](http://www.herbalyauto.hu)

Bring your life  
[thule.com](http://thule.com)

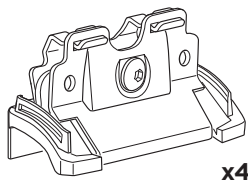

x4

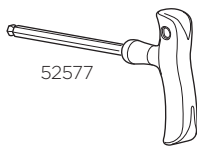

52577

x1



x1

1

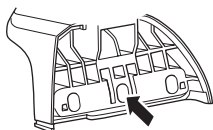

Thule Rapid System Foot Pack 753/7531  
Thule Podium Foot Pack 460/460R

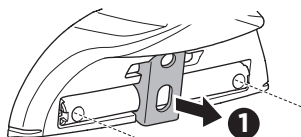

1

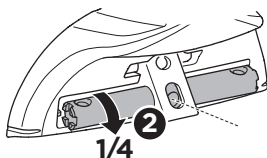

2  
1/4

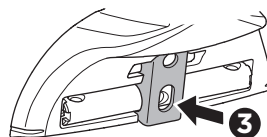

3

2

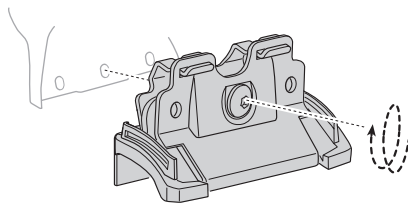

- EN** Only a few turns
- DE** Nur wenige Umdrehungen
- FR** Quelques tours uniquement
- NL** Slechts enkele slagen
- IT** Solo qualche giro
- ES** Sólo algunas vueltas
- PT** Apenas algumas voltas
- SV** Endast några varv
- DK** Kun nogle få omgange
- NO** Bare noen få omdreininger
- FI** Vain muutama kierros

- ET** Ainult mõni pööre
- LV** Tikai daži apgriezieni
- LT** Tik keli pasukimai
- PL** Wystarczy kilka obrotów
- RU** Только несколько оборотов
- UK** Лише декілька обертів
- BG** Само няколко завъртания
- CS** Pouze několik otáček
- SK** Len niekoľko otáčok
- SL** Le nekaj obratov
- HR/BiH** Samo nekoliko okreta
- RO** Doar câteva rotiri
- HU** Csak néhány fordítás
- EL** Μόνο λίγες περιστροφές
- TR** Yalnızca birkaç tur

بعض دورات فقط

**AR**

רק מספר סיבובים

**HE**

- ZH** 仅几圈
- JA** 2～3回転のみ
- KO** 몇 번만 돌리면 됨
- TH** เพียงสองสามรอบ

3

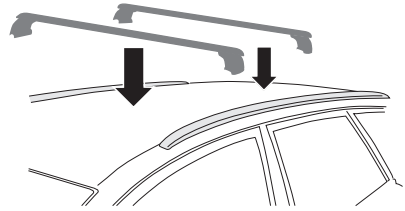

4

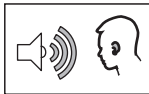
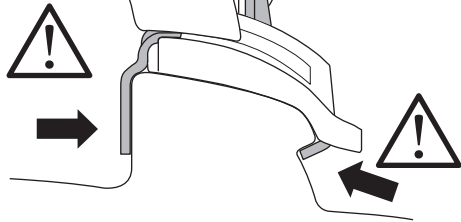
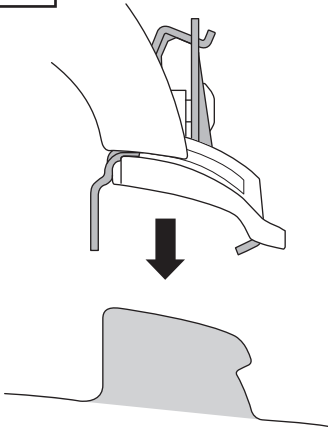

~ 700 mm

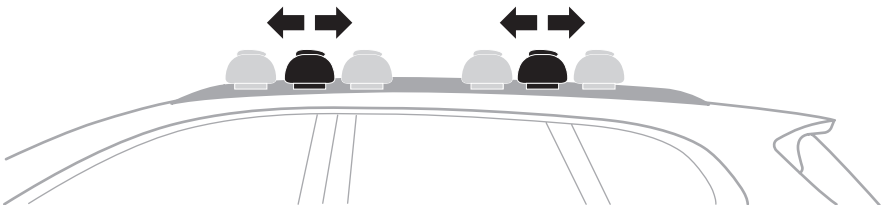
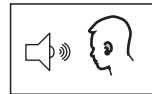

**5**

- |           |   |               |   |
|-----------|---|---------------|---|
| <b>EN</b> | Tighten alternately                                     | <b>UK</b>     | Затягти по чергово                                  |
| <b>DE</b> | Die Schrauben abwechselnd anziehen                      | <b>BG</b>     | Затегнете последователно                            |
| <b>FR</b> | Serrer alternativement chaque côté                      | <b>CS</b>     | Pokřetla багаžníka dokřečaj dokřečaj naprzemiennie. |
| <b>NL</b> | Afwisselend aan de linker- en de rechterkant aandraaien | <b>SK</b>     | Dotahujte striedavo                                 |
| <b>IT</b> | Alternare il serraggio delle viti                       | <b>SL</b>     | Privijajte izmenično                                |
| <b>ES</b> | Apretar alternativamente                                | <b>HR/BIH</b> | Naizmjenično zategnite                              |
| <b>PT</b> | Aperte alternadamente                                   | <b>RO</b>     | Strângeți alternativ                                |
| <b>SV</b> | Dra åt växelvis   | <b>HU</b>     | Egy mástól függetlenül szorítandó                   |
| <b>DK</b> | Spænd skiftevis   | <b>EL</b>     | Σφίγγετε εναλλάξ                                    |
| <b>NO</b> | Trekk til vekselvis                                     | <b>TR</b>     | Dönüşümlü sıkın                                     |
| <b>FI</b> | Kierrä vuorotellen                                      |               | إحكام الربط بالتناوب <b>AR</b>                      |
| <b>ET</b> | Pinguldage vaheldumisi                                  |               | חזק לסימון <b>HE</b>                                |
| <b>LV</b> | Pievelciet pamīšus                                      | <b>ZH</b>     | 交替拧紧  |
| <b>LT</b> | Užsukinėkite pakaitomis                                 | <b>JA</b>     | 左右交互に締めつけてください                                      |
| <b>PL</b> | Śruby dokręcaj naprzemiennie                            | <b>KO</b>     | 번갈아 조이기   |
| <b>RU</b> | Затягивайте попеременно                                 | <b>TH</b>     | ขันในแบบสลับ  |

